



T&S BRASS AND BRONZE WORKS, INC.

2 Saddleback Cove / P.O. Box 1088
Travelers Rest, SC 29690

Model No.

B-2866-05

Item No.

Travelers Rest, SC: 800-476-4103 • Simi Valley, CA: 800-423-0150 • Fax: 864-834-3518 • www.tsbrass.com

This Space for Architect/Engineer Approval

Job Name _____ Date _____

Model Specified _____ Quantity _____

Customer/Wholesaler _____

Contractor _____

Architect/Engineer _____

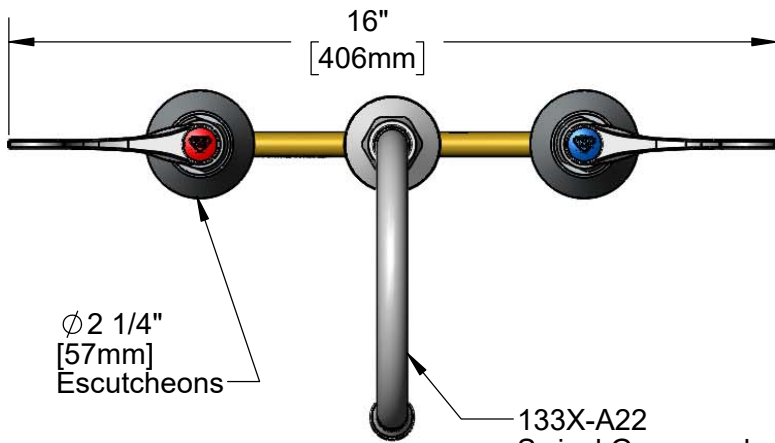

ADA Compliant

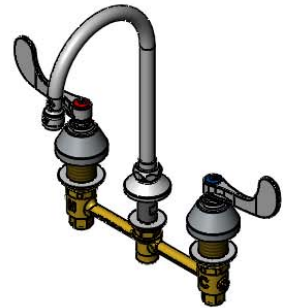

133X-A22
Swivel Gooseneck w/
2.2 GPM Aerator.
Rigid Conversion Requires
014200-45 Lock Washer
(Included)

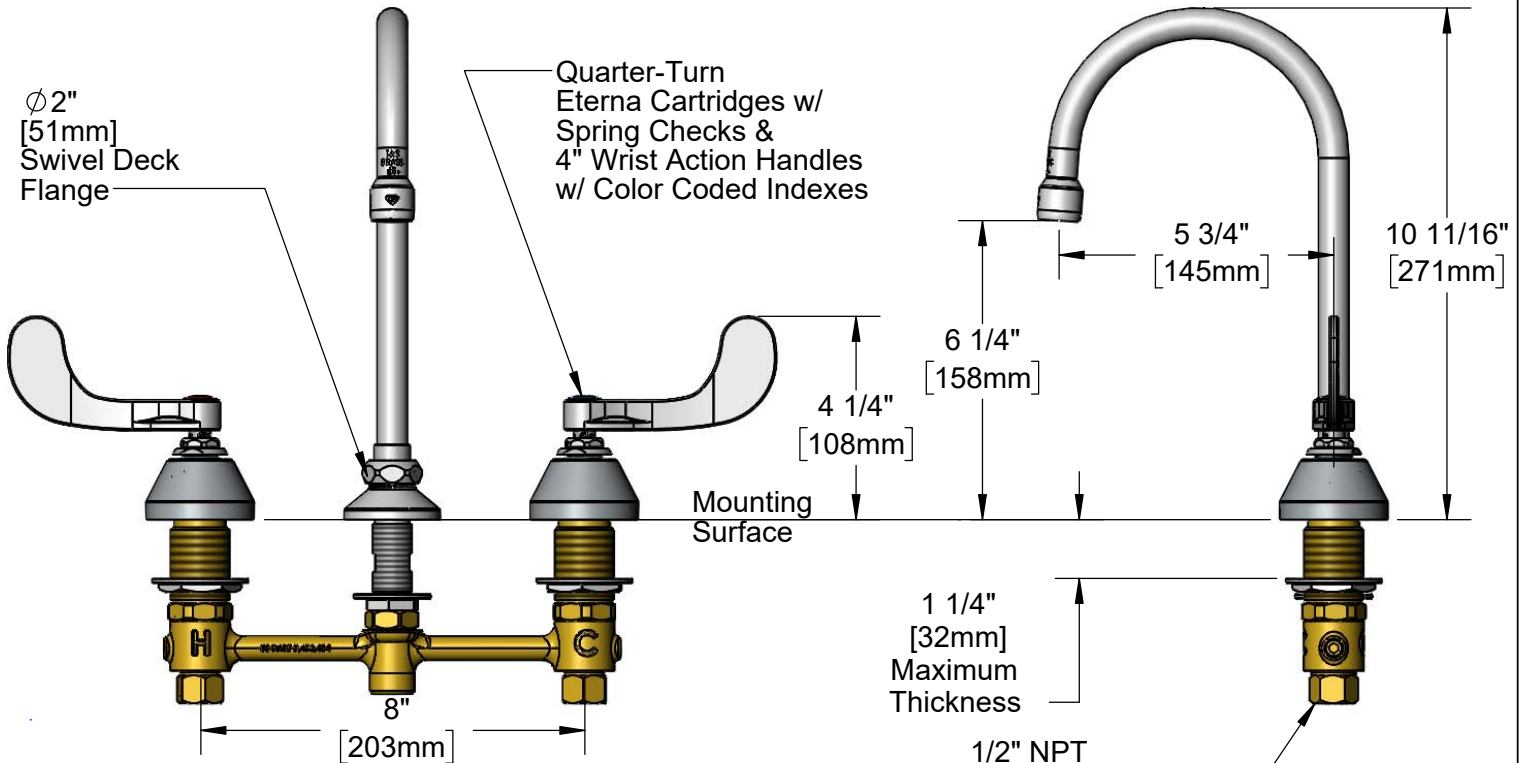

Rough-In Requirement:
Center Shank: Ø 1" [25mm] Mounting Hole
Hot/Cold Sides: Ø 1 1/2" [38mm] Mounting Holes

Product Specifications:
8" Concealed Widespread EasyInstall Mixing Faucet, 4" Wrist Action
Handles, Quarter-Turn Eterna Cartridges w/ Spring Checks & 5 3/4"
Rigid/Swivel Gooseneck w/ 2.2 GPM Aerator & 1/2" NPT Male Inlets

Product Compliance:
ASME A112.18.1 / CSA B125.1
NSF 61 - Section 9
NSF 372 (Low Lead Content)
ANSI A117.1 (ADA)



T&S BRASS AND BRONZE WORKS, INC.

2 Saddleback Cove / P.O. Box 1088
Travelers Rest, SC 29690

Model No.

B-2866-05

Item No.

Travelers Rest, SC: 800-476-4103 • Simi Valley, CA: 800-423-0150 • Fax: 864-834-3518 • www.tsbrass.com

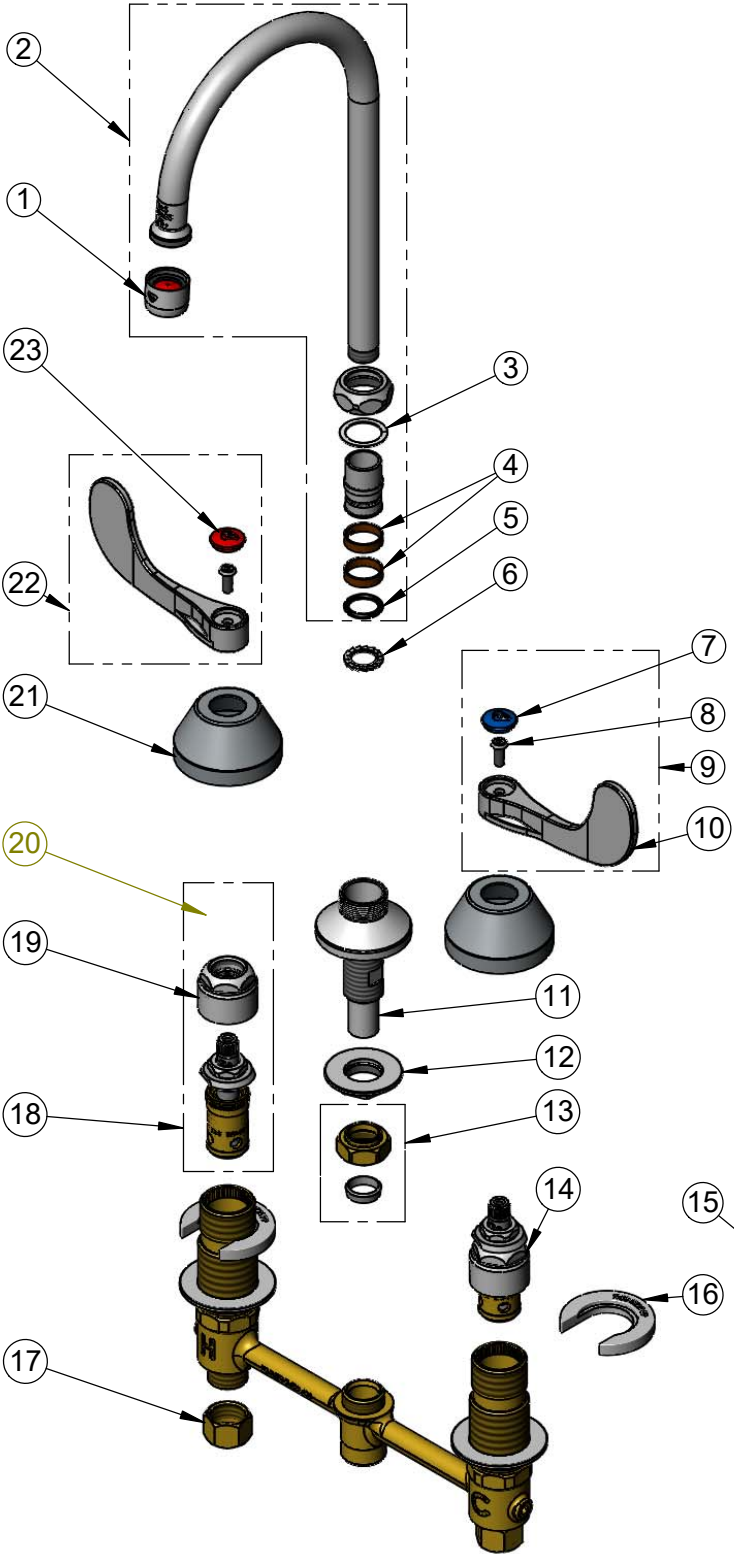

ITEM NO.	SALES NO.	DESCRIPTION
1	B-0199-01	2.2 GPM Aerator, 55/64-27 UN Female
2	133X-A22	5 3/4" Swivel Gooseneck w/ 2.2 GPM Aerator
3	009538-45	Swivel Washer
4	011429-45	Swivel Sleeves (2)
5	001074-45	O-Ring
6	014200-45	Star Washer, Anti-Rotation
7	018506-19NS	Blue Button Index, Press-in
8	000925-45	Lab Handle Screw
9	B-WH4C-NS	Wrist Action Handle, Screw & Cold Index
10	B-WH4-NS	Wrist Action Handle - New Style
11	016754-40NS	EasyInstall CWS Swivel Center Shank
12	016742-45	Center Flange Nut
13	016745-45	Compression Nut & Fitting
14	016752-40NS	EasyInstall, CWS Quarter-Turn Eterna Cartridge w/ Spring Check, LTC
15	016777-45	CWS Hanger
16	016749-45	Sidebody C-Washer
17	000958-20	Coupling Nut
18	016753-40NS	EasyInstall, CWS Quarter-Turn Eterna Cartridge w/ Spring Check, RTC
19	016743-25	CWS Eterna Bonnet
20	009002-40NS	Packing Assembly (New Style)
21	001257-40NS	Bell Escutcheon
22	B-WH4H-NS	Wrist Action Handle, Screw & Hot Index
23	001193-19NS	Red Button Index, Press-in

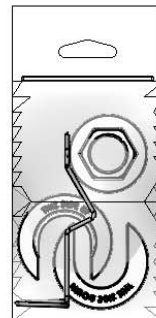

017245-40
Installation Repair Kit
Includes #12, (2)#16, & #15

Product Specifications:
8" Concealed Widespread EasyInstall Mixing Faucet, 4" Wrist Action Handles, Quarter-Turn Eterna Cartridges w/ Spring Checks & 5 3/4" Rigid/Swivel Gooseneck w/ 2.2 GPM Aerator & 1/2" NPT Male Inlets

Product Compliance:
ASME A112.18.1 / CSA B125.1
NSF 61 - Section 9
NSF 372 (Low Lead Content)
ANSI A117.1 (ADA)